

PRICE LIST

2023

SALES PRICE LIST AND TECHNICAL DATA

VALID AS OF JUNE 01.2023

HSM
Paint finishing systems
for professionals





1 System
4 Sizes



MIXING-CUP SYSTEM



1 Adapter
2 Systems



SPA SYSTEMS easy line & easy line mix

1 System
7 Sizes



ACE SPE-SYSTEM Injector inserts



TABLE OF CONTENTS

PAGES

MIXING-CUP SYSTEM

HSM	4 – 5
SIKKENS	6 – 7
LESONAL	8 – 9

SPA SYSTEMS

TECHNICAL DATA	11
EASY LINE MIX – HSM	12
EASY LINE MIX – SIKKENS	13
EASY LINE MIX – LESONAL	14
EASY LINE	15
ACCESSORIES	16
ADAPTER	17
CROSS-REFERENCES	18 – 19

SPE-SYSTEM

THE PRINCIPLE	20
INJECTOR INSERT	21 – 22
DÜRR ECOGUN ACE	23





TECHNICAL DATA

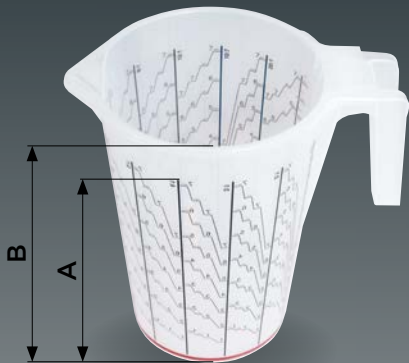

MATERIAL

- 1** Exterior container Polypropylene (PP)
- 2** Cup insert Polypropylene (PP)
- 3** Lid Polyethylene (PE)

MIXING RATIOS

- 1:1 | 2:1 | 3:1 | 4:1 | 5:1 | 6:1 | 7:1 |
8:1 | 10:1 | 10:7 | 20:1

CUP INSERT VOLUME

		small	medium	large	maxi
Effective mixing volume „A“	[ml] approx.	500	1.000	2.000	5.000
Total volume „B“	[ml] approx.	660	1.280	2.550	6.000

WEIGHT

		small	medium	large	maxi
1 Exterior container	[g] approx.	65	117	184	410
2 Cup insert	[g] approx.	20	32	62	135
3 Lid	[g] approx.	13	19	24	60

MIXING-CUP SYSTEM

HSM

MIXING-CUP SYSTEM HSM	Delivery unit [1 carton = 240 inserts ② + 1 exterior container ①]	Article-No.	Recommended sales price without sales tax [€/Carton]
Model small	Carton	85 070	119,60
Model medium	Carton	85 140	141,70
Model large	Carton	85 250	208,00
	[1 carton = 100 inserts ② + 1 exterior container ①]		
Model small	Carton	82 070	60,60
Model medium	Carton	82 140	72,20
Model large	Carton	82 250	107,70
Model maxi	Carton	82 600	244,90
	[1 carton = 100 inserts ②]		
Model small	Carton	81 070	52,20
Model medium	Carton	81 140	61,50
Model large	Carton	81 250	91,24
Model maxi	Carton	81 600	220,70
	[1 carton = 25 inserts ② + 1 exterior container ① + 1 lid ③]		
Model small	Carton	80 070	29,20
Model medium	Carton	80 140	35,00
Model large	Carton	80 250	52,80
Model maxi	Carton	80 600	106,90

EXTERIOR CONTAINER HSM	Delivery unit [1 carton = 10 exterior containers ①]	Article-No.	Recommended sales price without sales tax [€/Carton]
Model small	Carton	85 000	86,40
Model medium	Carton	85 001	106,40
Model large	Carton	85 002	161,80
Model maxi	Carton	85 007	243,90

LID HSM	Delivery unit [1 Plastic bag = 50 lids ③]	Article-No.	Recommended sales price without sales tax [€/Carton]
Model small	Plastic bag	85 003	34,10
Model medium	Plastic bag	85 004	34,90
Model large	Plastic bag	85 005	36,20
Model maxi	Plastic bag	85 006	44,10

MIXING-CUP SYSTEM SIKKENS



TECHNICAL DATA

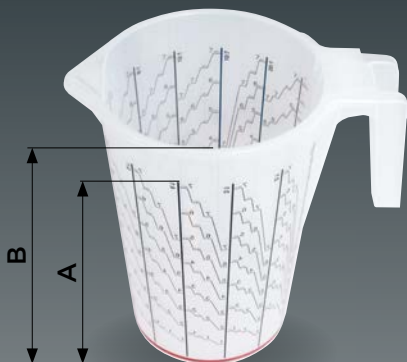

MATERIAL

- 1** Exterior container Polypropylen (PP)
- 2** Cup insert Polypropylen (PP)
- 3** Lid Polyethylen (PE)

MIXING RATIOS

- 100:50:10-30-40-50 | 100:10-20-30 |
- 100:60:20 | 3:1+10% | 3:1:1-2 |
- 5:1:1-2 | 6:1:3 | 100:25:35 | 3:3:1 |
- 100:50:30:30-40 | 100:40:30-60

CUP INSERT VOLUME

		small	medium	large
Effective mixing volume „A“	[ml]	approx. 500	approx. 1.000	approx. 2.000
Total volume „B“	[ml]	approx. 660	approx. 1.280	approx. 2.550

WEIGHT

		small	medium	large
1 Exterior container	[g]	approx. 65	approx. 117	approx. 184
2 Cup insert	[g]	approx. 20	approx. 32	approx. 62
3 Lid	[g]	approx. 13	approx. 19	approx. 24

MIXING-CUP SYSTEM SIKKENS

MIXING-CUP SYSTEM SIKKENS	Delivery unit [1 carton = 240 inserts ② + 1 exterior container ①]	Article-No.	Recommended sales price without sales tax [€/Carton]
Model small	Carton	84 070	119,60
Model medium	Carton	84 140	141,70
Model large	Carton	84 250	208,00

EXTERIOR CONTAINER SIKKENS	Delivery unit [1 carton = 10 exterior containers ①]	Article-No.	Recommended sales price without sales tax [€/Carton]
Model small	Carton	84 000	86,40
Model medium	Carton	84 001	106,40
Model large	Carton	84 002	161,80

LID SIKKENS	Delivery unit [1 Plastic bag = 50 lids ③]	Article-No.	Recommended sales price without sales tax [€/Carton]
Model small	Plastic bag	55 003	34,10
Model medium	Plastic bag	55 004	34,90
Model large	Plastic bag	55 005	36,20

MIXING-CUP SYSTEM LESONAL



TECHNICAL DATA

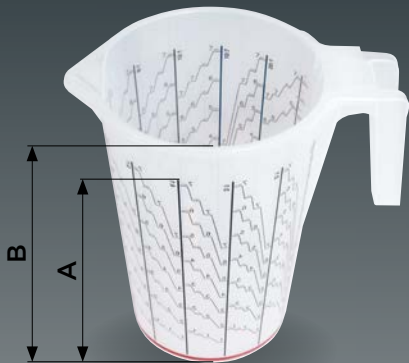

MATERIAL

- 1** Exterior container Polypropylen (PP)
- 2** Cup insert Polypropylen (PP)
- 3** Lid Polyethylen (PE)

MIXING RATIOS

2:1:10%-20% | 5:1:1-2 | 5:3:1 | 3:1:0,6-1 |
4:1:0,8 | 5:2:1 | 5:2,5:2 | 5:2:3 | 6:1:3 |
3:3:1

CUP INSERT VOLUME

		small	medium	large
Effective mixing volume „A“	[ml]	approx. 500	approx. 1.000	approx. 2.000
Total volume „B“	[ml]	approx. 660	approx. 1.280	approx. 2.550

WEIGHT

		small	medium	large
1 Exterior container	[g]	approx. 65	approx. 117	approx. 184
2 Cup insert	[g]	approx. 20	approx. 32	approx. 62
3 Lid	[g]	approx. 13	approx. 19	approx. 24

MIXING-CUP SYSTEM LESONAL

MIXING-CUP SYSTEM LESONAL	Delivery unit [1 carton = 240 inserts ② + 1 exterior container ①]	Article-No.	Recommended sales price without sales tax [€/Carton]
Model small	Carton	83 070	119,60
Model medium	Carton	83 140	141,70
Model large	Carton	83 250	208,00

EXTERIOR CONTAINER LESONAL	Delivery unit [1 carton = 10 exterior containers ①]	Article-No.	Recommended sales price without sales tax [€/Carton]
Model small	Carton	83 000	86,40
Model medium	Carton	83 001	106,40
Model large	Carton	83 002	161,80

LID LESONAL	Delivery unit [1 Plastic bag = 50 lids ③]	Article-No.	Recommended sales price without sales tax [€/Carton]
Model small	Plastic bag	55 003	34,10
Model medium	Plastic bag	55 004	34,90
Model large	Plastic bag	55 005	36,20



1 Adapter
2 Systems



SPA SYSTEMS easy line & easy line mix

The SPA system easy line and The SPA system easy line mix require an adapter between the cup and spray gun.

TECHNICAL DATA

SPA SYSTEM EASY LINE MIX



VOLUME CUP		small	medium	large
Spray volume	[ml] approx.	300	500	800
Total volume	[ml] approx.	390	660	950

MIXING RATIOS

HSM 1:1 | 2:1 | 3:1 | 4:1 | 5:1 | 6:1 | 7:1 | 8:1 | 9:1 | 10:1 | 20:1

SIKKENS 100:50:10-30-40-50 | 100:10-20-30 | 100:60:20 | 3:1+10% | 3:1:1-2 | 5:1:1-2 | 6:1:3 | 100:25:35 | 3:3:1 | 100:40:30-60

LESONAL 2:1:10%-20% | 5:1:1-2 | 5:3:1 | 3:1:0,6 | 4:1:0,8 | 5:2:1 | 5:2,5:2 | 5:2:3 | 6:1:3 | 3:3:1

MATERIAL

5	Disposable cup	Polypropylene (PP)
2 3	Lid	Polyethylene (PE)
4	Screen insert and screen fabric	Polyamide (PA), Nylon
1	Adapter	V2A

WEIGHT		small	medium	large
2 3 5	Complete disposable cup	[g] approx. 36	55	65
4	Screen insert	[g] approx.	1	
1	Adapter	[g] approx.	20-30 (depending on design)	

SPA SYSTEM EASY LINE



VOLUME CUP		small	medium	large
Spray volume	[ml] approx.	550		
Total volume	[ml] approx.	730		

MATERIAL

2 3 5	Complete disposable cup	Polypropylene (PP)
4	Screen insert and screen fabric	Polyamide (PA), Nylon
1	Adapter	V2A

WEIGHT		small	medium	large
2 3 5	Complete disposable cup	[g] approx. 45		
4	Screen insert	[g] approx.	1	
1	Adapter	[g] approx.	20-30 (depending on design)	

**EASY LINE MIX**

HSM

Delivery unit
[1 carton = 60 cups with FlipFlop connection ⑤
+ lids, red ③ including locking cap ②]

Article no.

Recommended sales price without sales tax
[€/Carton]

Model **small**

Carton

67 300

112,60Model **medium**

Carton

67 500

135,20Model **large**

Carton

67 800

168,80**LID**

HSM

Delivery unit
[1 carton = 20 lids, red ③
including locking cap ②]

Article no.

Recommended sales price without sales tax
[€/Carton]

Model **small**

Carton

67 002

26,90Model **medium / large**

Carton

67 001

28,30

SPA-SYSTEM EASY LINE MIX

SIKKENS



EASY LINE MIX SIKKENS	Delivery unit [1 carton = 60 cups with FlipFlop connection ③ + lids, white ③ including locking cap ②]	Article no.	Recommended sales price without sales tax [€/Carton]
Model small	Carton	66 300	112,60
Model medium	Carton	66 500	135,20
Model large	Carton	66 800	168,80

LID SIKKENS	Delivery unit [1 carton = 20 lids, white ③ including locking cap ②]	Article no.	Recommended sales price without sales tax [€/Carton]
Model small	Carton	65 002	26,90
Model medium / large	Carton	65 001	28,30

SPA-SYSTEM EASY LINE MIX

LESONAL



EASY LINE MIX

LESONAL

Delivery unit
[1 carton = 60 cups with FlipFlop connection ⑤
+ lids, white ③ including locking cap ②]

Article no.

Recommended sales price without sales tax
[€/Carton]

Model **small**

Carton

65 300

112,60

Model **medium**

Carton

65 500

135,20

Model **large**

Carton

65 800

168,80

LID

LESONAL

Delivery unit
[1 carton = 20 lids, white ③
including locking cap ②]

Article no.

Recommended sales price without sales tax
[€/Carton]

Model **small**

Carton

65 002

26,90

Model **medium / large**

Carton

65 001

28,30



EASY LINE HSM	Delivery unit [1 carton = 60 cups ③ + lids with FlipFlop connection ④ including locking cap ②]	Article no.	Recommended sales price without sales tax [€/Carton]
Cup system	Carton	68 000	132,70

LID HSM	Delivery unit [1 carton = 30 lids with FlipFlop connection ④ including locking cap ②]	Article no.	Recommended sales price without sales tax [€/Carton]
Replacement lid for SPA easy line	Carton	68 001	31,20

SPA SYSTEMS ACCESSORIES



SPA-SCREEN INSERTS

HSM SPA SYSTEM

Delivery unit
[1 Carton = 60 screen inserts + 1 applicator]























Article no.

Recommended sales price without sales tax
[€/Bag]

	Mesh 105 µm (red)	Carton	70 105	53,10
	Mesh 125 µm (green)	Carton	70 125	53,10
	Mesh 195 µm (blue)	Carton	70 195	53,10

SPA SYSTEMS

SCREWED CONNECTION

SCREWED CONNECTION		Thread dimensions	Thread view on the gun	Delivery unit [1 plastic bag = 1 piece]	Recommended sales price without sales tax [€/plastic bag]
	Adapter 68 002	M 16 x 1,5	exterior	Plastic bag	48,50
	Adapter 68 003	M 16 x 1,5	interior	Plastic bag	48,50
	Adapter 68 004	M 12 x 1	exterior	Plastic bag	48,50
	Adapter 68 005	G 3/8"	interior	Plastic bag	48,50
	Adapter 68 006	G 1/4"	interior	Plastic bag	48,50
	Adapter 68 007	M 12 x 1,5	interior	Plastic bag	48,50
	Adapter 68 008	Bayonet mini	–	Plastic bag	48,50
	Adapter 68 009	M 10 x 1	interior	Plastic bag	48,50
	Adapter 68 010	G 3/8"	exterior	Plastic bag	48,50
	Adapter 68 011	W 17,5 x 19GG	exterior	Plastic bag	48,50
	Adapter 68 012	M 16 x 1	interior	Plastic bag	48,50
	Adapter 68 013	Bayonet	–	Plastic bag	48,50
	Adapter 68 014	5/8"–11UNC	interior	Plastic bag	48,50
	Adapter 68 015	Rd 16 x 1/8"	exterior	Plastic bag	48,50
	Adapter 68 016	M 12 x 1	interior	Plastic bag	48,50
	Adapter 68 017	M 14 x 1,25	interior	Plastic bag	48,50
	Adapter 68 018	M 12 x 0,75	interior	Plastic bag	48,50
	Adapter 68 019	7/16"–14 UNC	interior	Plastic bag	48,50
	Adapter 68 020	G 1/4"	interior	Plastic bag	48,50
	Adapter 68 021	G 1/8"	interior	Plastic bag	48,50
	Adapter 68 022	M 18 x 1,5	interior	Plastic bag	48,50
	Adapter 68 023	G 1/4"	interior	Plastic bag	48,50

SCREWED CONNECTION – CROSS-REFERENCES

	HSM ADAPTER	68 002	68 003	68 004	68 005	68 006	68 007	68 008	68 009	68 010
	THREAD DIMENSIONS	M 16 × 1,5	M 16 × 1,5	M 12 × 1	G 3/8"	G 1/4"	M 12 × 1,5	Bayonet	M 10 × 1	G 3/8"
	THREAD VIEW ON THE GUN	exterior	interior	exterior	interior	interior	interior	mini	interior	exterior
AirGunsa AZ3 HTE2, Impact AZ3 HTS-S										
AirGunsa Impact Junior Az4 HTE-S, Concept HTE P.A.S.										
ALUP							●			
Anest IWATA LPH-80										
Anest IWATA LPH 300, W-300 Series										
Anest IWATA LPH-400, LPA94		●								
Anest IWATA VXL Primer Gun W-400 Series, WR 400		●								
Anest IWATA WS-400 evo (Supernova), LS 400 (Supernova)										
Asturo										
Chiron 22090, 22091										
DETE GGM 15		●								
DETE GGM 24										
DETE GGM 25						●				
DeVilbiss PRI, GTI, GFP, GFV, GFHV 510					●					
DeVilbiss SRI										
EW0										
Graco Air Pro										
Graco FINEX			●							
Graco LT		●								
Graco Razor										
Graco XT					●					
Iseco										
Krautzberger*										
Kremlin*						●				
Optima										●
Rodcraft 8102, 8106		●								
SAGOLA Extrem 4400G, 4500 G*										
SAGOLA 403 G, 433 G, 434 G, 444 G, 450 G, 4100 G, 4200 G*							●			
SAGOLA 475 Mini-Gun*									●	
SATA LM 92, LMS, MC 93							●			
SATAjet 100, 1000, 2000, 3000, 4000, 5000, 5500										
SATAjet 2000 Series (LM/NR) without bayonet connection			●							
SATAjet 90, KLC, MCB, RP			●							
SATAjet B, GR, NR 92, NR 95		●								
SATAminijet 1, 2, 3									●	
SATAminijet 4 with bayonet connection								●		
SATAminijet 4400 with bayonet connection										
Schneider*							●			
Schütze W1 and W2										
Wagner*							●			
WALCOM Genesis Carbon			●							
WALCOM FX Geo, FX HVLP*										
Walther							●			
Walther Pilot Premium										
ZERO DERR				●						

*subject to change

THE ACE-SPE SYSTEM LACQUER GUN WITH REPLACEABLE INJECTOR INSERTS.

Discover the unique ACE-SPE system principle that saves you time and reduces how much cleaning agent you use, while making you more productive than ever.



After use, the injector insert is completely replaced



Paint residues are automatically removed from the needle when changing the injector insert



All that is left to do is clean the needle tip



CLEANING AGENT CONSUMPTION

ACE-SPE System injector insert		Ø 25 ml
Conventional lacquer gun		Ø 250 ml

CLEANING TIME

ACE-SPE System injector insert		Ø 30 sec.
Conventional lacquer gun		Ø 5 min.

THE ACE-SPE SYSTEM INJECTOR INSERT IS A NEXT-GENERATION PRECISION COMPONENT.

With sizes from 1.2 mm to 2.5 mm, the system can be used for all painting & lacquering tasks and guarantees highly reproducible spraying results.

By changing the injector insert, you avoid cross-contamination when switching colours as well as spraying results of inferior quality and blockages caused by residues in the paint duct. Swapping out the insert therefore enables permanently excellent spraying performance equivalent to using a new gun.

The advanced design means that cleaning is fast and straightforward. Only the paint needle tip has to be cleaned, without completely disassembling or soaking the lacquer gun. This allows you to optimise your workflows and saves you valuable time.

Using less cleaning agent is better for the environment and also extends the service life of your premium lacquer gun.

We take various protective steps to ensure that the injector inserts reach their destination intact. This begins directly at the production facility, for example, where a protective cap is immediately put on once the serial number has been engraved.

NEW ACE-SPE SYSTEM INJECTOR INSERT

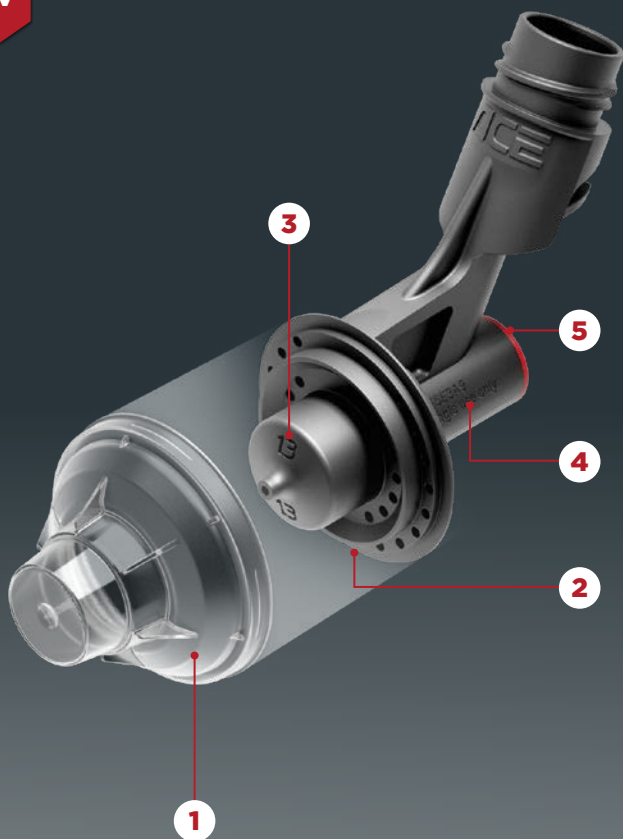

MATERIAL

1	Protective cap	Polypropylene (PP)
2 5	Injector insert Sealing plug	Polypropylene (PP)

WEIGHT

1	Protective cap	1,0 g
2 5	Injector insert	7,5 g

DESCRIPTION

- 1 Protective cap
This precision component is sealed by the stable cap for protection against external factors during transport. The cap is simply removed before use.
- 3 Injector size
In order to define and differentiate the injector sizes, the size is indicated at the front above the injector.
- 4 Serial number
Every component is visually inspected and measured. A serial number for traceability is engraved on the injector insert using laser technology and the data is archived for warranty claims.

ACE-SPE SYSTEM INJECTOR INSERTS

INJECTOR INSERT ACE-SPE SYSTEM	Delivery unit [1 Ziplock Bag = 20 injector inserts]	Article no.	Recommended sales price without sales tax [€/Carton]
Model 1.2 mm	Ziplock Bag	46 012	97,00
Model 1.3 mm	Ziplock Bag	46 013	97,00
Model 1.4 mm	Ziplock Bag	46 014	97,00
Model 1.6 mm	Ziplock Bag	46 016	97,00
Model 1.8 mm	Ziplock Bag	46 018	97,00
Model 2.0 mm	Ziplock Bag	46 020	97,00
Model 2.5 mm	Ziplock Bag	46 025	97,00

ALWAYS THE RIGHT INJECTOR SIZE

COATING SYSTEMS	INJECTOR INSERT						
	1.2	1.3	1.4	1.6	1.8	2.0	2.5
Paints and lacquers with a high viscosity					●	●	●
Spray filler					●	●	●
Thick film filler			●	●	●	●	●
Sanding filler			●	●	●		
Wet-in-wet filler		●	●				
Universal top-coat paint / lacquer		●	●				
Solvent-based paints / lacquers		●	●				
Clear paint / lacquer	●	●	●				
Base coat	●	●					
UV filler	●	●					
Effect paints / lacquers	●	●					
Smart / minor damage repairs	●						

TECHNICAL DATA



DESCRIPTION

- 1** Air cap

- 2** Flat jet regulation

- 3** Plastic injector/injector insert (with cup connection)

- 4** Air regulation

- 5** Lock nut

- 6** Stop screw (quick-clip technology)

- 7** G1/4" pneumatic connector

ACE-SPE SYSTEM DÜRR ECOGUN ACE

AIR CAPS

CONVENTIONAL/CF

Air consumption (depending on the air cap type and air pressure)	[NI/min]	240 - 280
Transmission rate	[%]	> 65

LVLPL/LF

Air consumption (depending on the air cap type and air pressure)	[NI/min]	265 - 310
Transmission rate	[%]	> 75

AIR PRESSURE

Maximum	[bar]	7,0
Recommended	[bar]	2,0 - 3,0

OPERATING TEMPERATURE

Minimum	[°C]	10
Maximum	[°C]	40

INJECTOR SIZE

Total of seven sizes	[Ø/mm]	1.2/1.3/1.4/1.6 1.8/2.0/2.5
----------------------	--------	--------------------------------

HOUSING

Material / Colour	Aluminium, anodised in blue
-------------------	--------------------------------

WEIGHT

with plastic injector, without cup	[g]	418
------------------------------------	-----	-----

HOW TO SOURCE

Online via the link

[HTTPS://SHOP.DURR.COM/](https://shop.durr.com/)

or by phone from your contact

ULRICH TAUTZ
SALES

+49 7142 78-0
sales@durr.com

MAKE. NO. COMPROMISES.

WELL DESIGNED SYSTEMS
IN PERFECT HARMONY.



HSM Lackiersysteme GmbH
Braike 77 · 73230 Kirchheim unter Teck
GERMANY

T: +49 (0) 70 21.972 208-0
info@hsm-lackiersysteme.de
www.hsm-lackiersysteme.de



With the publication of this price list, previous price lists and offers lose their validity. Our general terms and conditions apply.
We accept no liability for printing errors and/or for the use of the data (text/image). All images are for visualisation purposes only and are only extracts from our product range.

Valid as of June 01. 2023